

MFLEX LIGHT SYSTEM

RAPID HANG GUIDE



FRONTLINE
Lighting





Here's your new MFlex Light System.

LET'S GET YOU UP TO SPEED ON WHAT'S INSIDE.

A HANGING STRAP

B CORDURA® MFLX CARRYING CASE

C FULLY ASSEMBLED LED LIGHT STRIPS, INCLUDING:

- MFlex 12-meter white light strip
- MFlex 12-meter blackout light strip
- 16 Hanging clips
- 16 Hanging hooks
- 16 Cord locks

D LED Y POWER CABLE

E 24 VDC POWER CABLE

If connecting to a NATO-approved battery, use a Frontline battery cable only or damage to the unit could result.



F CONTROL PANEL AND LIGHT SWITCHES

Includes toggle switch, dimmer control

G 24 VDC POWER DRIVER

Located beneath control panel; hub connector and 24 VDC connector cables attached inside. Connections accessed through top of bag.



REVIEW the contents to ensure you have everything needed to get started.



Take a closer look at the control panel.

THIS IS WHERE YOU'LL OPERATE THE LIGHTS.

A ON/OFF LIGHTING CONTROL DIAL

Adjusts light output to low, medium or high.

B LED TOGGLE

Switches between white light, neutral and blackout operations.



INSPECT the control panel carefully. Make sure the lighting control dial turns smoothly and clicks off and on. Then check the LED toggle, listening for a hard click at each setting.

Let's get started.

A FIRST identify the best spot inside the shelter to hang the carrying case. Choose a central location where it's easy to access the control panel and regulate the lighting.

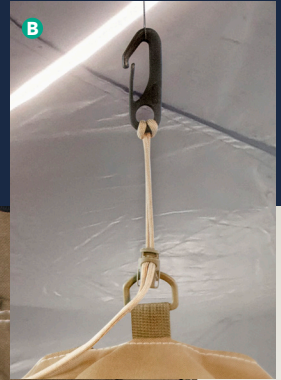

B HANG the carrying case. Run a D-clip through the hanging strap, and then connect it to an embedded O-ring on the shelter wall.

C CONNECT the 24 VDC power cable to the 120V power cable extending out the side, and plug into an AC outlet.

If connecting to a NATO-approved battery, use a Frontline battery cable only or damage to the unit could result.



D CONNECT the LED Y power cable to the 24 VDC Out port, located on top of the control box inside the case.

Plan your lighting configuration.

DECIDE which hanging pattern works best to provide light where you need it. Here are several common layouts, but you can hang the lights in whichever pattern meets your mission requirements.

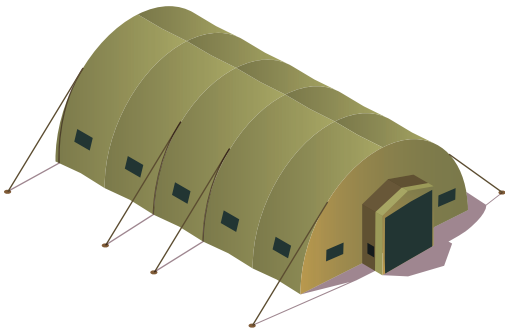
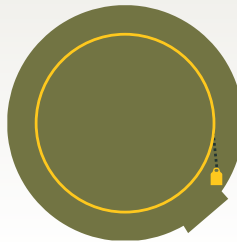
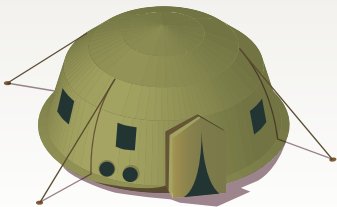
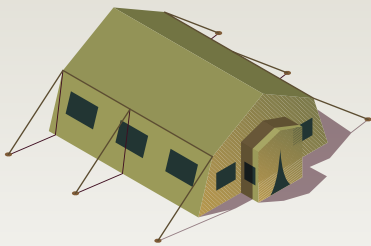

MFLEX strips may need to be hung closer to the wall in smaller shelters, and 4-6 feet from the wall in larger shelters since the LEDs radiate at 180°.

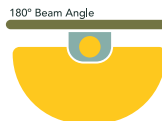

Hang the lights.

MFLEX LIGHT STRIPS COME PREHUNG.
SO THEY CLIP QUICKLY TO SHELTER RIBBING.

UNROLL the light strips, keeping the male connectors closest to the carrying case. Lay the strips out flat and in parallel, making sure there are no twists in the lines.

DO NOT illuminate the lights when they are rolled up.

CONNECT the male ends of the LED light strips to the female ends of the LED Y power cable. Press the prongs into the openings and twist to lock. White and blackout lights are clearly marked for easy matching.

START hanging the lights, beginning with the hanging hook closest to the carrying case. Snap the first S-clip hanging hook onto the nearest O-ring embedded in the shelter roof.

SNAP the remaining hanging hooks onto the shelter ceiling to achieve your lighting pattern. If you need to move the hanging clips to align better with the O-rings, simply slide them forward or backward.

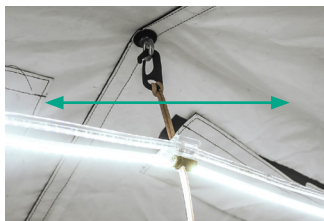

Adjust the lights.

TOGGLE UP.
TOGGLE DOWN.
IT'S A CINCH TO DIRECT LIGHT
WHERE YOU NEED IT.

RAISE or lower the lights as needed by cinching the toggle-knob cord lock up or down. For a neat finished appearance, tie down any loose cords so none are visible.

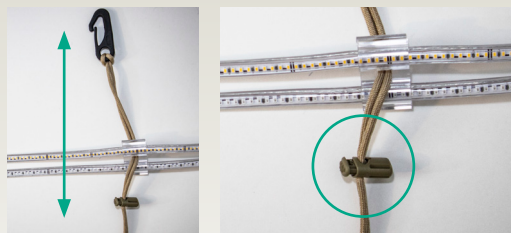

Power up the lights.

TURN on the lights using the control dial and commence operations. Set your lights to the desired brightness and adjust as needed.



Shelter striking operations.

UNPLUG the MFlex Lighting System from the AC power outlet. The LED light strips will remain in the shelter once packed.

STORE the MFlex carrying case in a safe location until the next use.



Need replacement parts?

HERE'S HOW TO ORDER THEM.

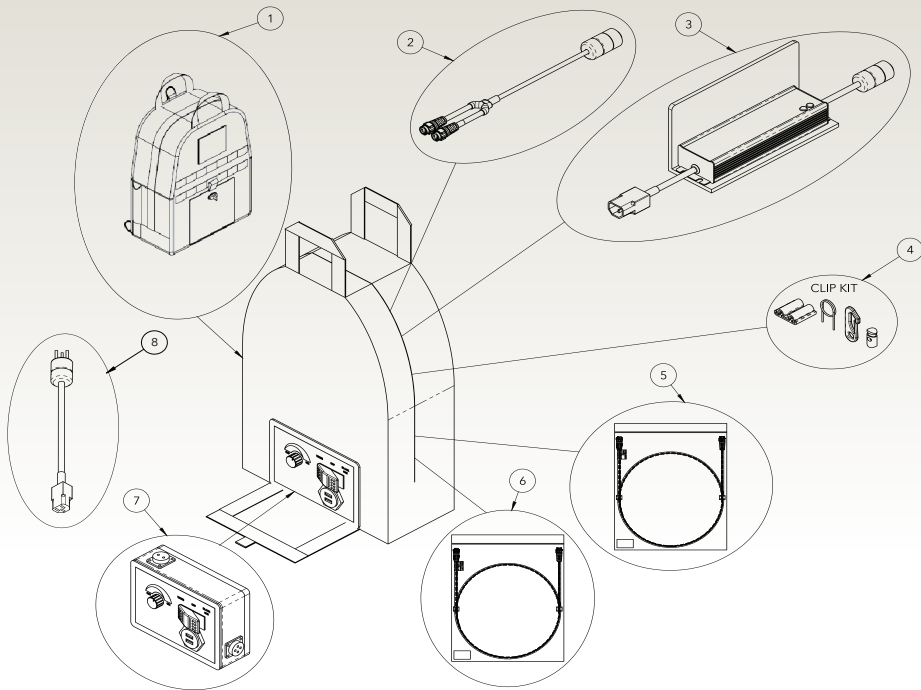

MFLEX LIGHT KIT COMPONENTS AND PART NUMBERS

- | | |
|----------------------------------|--------------------|
| 1 MFflex light system carry case | MFLK-Kit-Bag-0001 |
| 2 LED Y power cable | MFLK-PWRCBL-0001 |
| 3 Power supply with connectors | MFLK-PS-0001 |
| 4 Hanging clip kit | MFLK-HNGKIT-0001 |
| 5 24VDC White LED light - 12m | WHT-CBL-12 |
| 6 24VDC Blackout LED light - 12m | BLK-CBL-12 |
| 7 Main control box and bracket | MFLK-CNTL-BOX-0001 |
| 8 Universal power cable | MFLK-INT-POWER-CBL |

CALL US. 724.841.0101

SEND AN EMAIL. admin@FrontlineLighting.com

ORDER ONLINE. frontlinelighting.com

WARNINGS!

Failure to follow these instructions may result in injuries, fatalities or permanent damage of the MFlex Light Kit system and void the warranty.

- Only use an external power supply input within these specifications: 100-277 Vac @ 50/60Hz.
- Never power lights inside the Kit Bag.
- Never power lights when coiled. EXCEPTION: In freezing conditions (32°F/0°C or below), apply power to the lights for 1 minute before uncoiling for use.
- A maximum of 15 meters of lights can be run from each DC circuit.
- Do not store or operate the Light Kit next to any open flame.
- Protect lights and wiring from being cut or stretched.
- Do not hang anything from the lights or power cables.
- Always disconnect lights from power source before servicing.
- Do not immerse the Light Kit in water.
- Clean only with a soft dry cloth. Do not use solvents or abrasive materials.
- Avoid long-term eye contact with the lights when illuminated.

LIMITED 1-YEAR WARRANTY

View details at frontlinelighting.com.

To receive a copy of the warranty, contact:

US.sales@frontlinelighting.com 724-841-0101

INT.sales@frontlinelighting.com +61-419-209-108

FRONTLINE LIGHTING, LLC

545 Chicora Road

Suite 9B

Butler, PA 16001

US.sales@frontlinelighting.com 724-841-0101

INT.sales@frontlinelighting.com +61-419-209-108